



**INTERNATIONAL
DATA COLLECTION SYSTEM
USERS' GUIDE**

Issue 10, Version 1

October 2009

EDITOR'S NOTE

The present revision of the International Data Collection System User's Guide has been prepared by EUMETSAT, acting as the CGMS Secretariat.

Any query concerning this document should be addressed to:

EUMETSAT User Service
Eumetsat-Allee 1
64295 Darmstadt
Germany

Telephone: +49 (0) 6151 807 366
Fax: +49 (0) 6151 807 304
E-mail: ops@eumetsat.int

TABLE OF CONTENT

1	INTRODUCTION	1
2	THE GEOSTATIONARY METEOROLOGICAL SATELLITES.....	1
3	CGMS - A SHORT HISTORY	2
4	THE INTERNATIONAL DATA COLLECTION SYSTEM.....	3
5	DATA COLLECTION PLATFORM	3
6	DCP REPORT	4
7	DCP DESIGN.....	6
8	DCP CERTIFICATION	6
8.1	General	6
8.2	Certification Specifications.....	6
8.3	DCP Radio Set Certificate.....	6
9	ADMISSION	7
10	SERVICES PROVIDED BY SATELLITE OPERATORS.....	8
10.1	Collection of Data.....	8
10.2	Eclipse Operation.....	8
10.3	Data Processing.....	8
10.4	Monitoring of DCP Performance	10
10.4.1	Monitoring services.....	10
10.5	Data Distribution	10
10.5.1	Distribution of data by EUMETSAT.....	11
10.5.2	Distribution of data by USA	11

LIST OF ANNEXES

ANNEX 1	Glossary of terms and list of acronyms
ANNEX 2	DCP report characteristics
ANNEX 3	DCP design
ANNEX 4	Certification specifications
ANNEX 5	Address list for Engineering Matters (Satellite Operators)

1 INTRODUCTION

One of the functions of the system of geostationary meteorological satellites is the collection of environmental data from Data Collection Platforms (DCP). The coordination needed to define a truly international system of data collection from these satellites has been conducted under the auspices of the Coordination Group for Meteorological Satellites (CGMS).

This International Data Collection System (IDCS) Users' Guide contains a complete description of the international system. It provides specifications and guidelines for the design of platforms, describes the procedures for certification and admission, and details the operational support provided for the platforms.

The reader should note that this Guide is applicable only to International Data Collection Platforms, as agreed between CGMS members.¹ It provides information on the technical characteristics of this international service. The coordinating role of the World Meteorological Organization (WMO) is also described.

The Guide does not, however, attempt to provide full details of services which may be provided by each individual satellite operator on a regional basis. Such details should be obtained from the satellite operators directly (see Annex 5 for list of addresses).

2 THE GEOSTATIONARY METEOROLOGICAL SATELLITES

Since 1979, four geostationary Meteorological satellite systems have been in continuous operation:

- | | |
|-----------------------|----------|
| - GOES East (USA) | at 75°W |
| - GOES West (USA) | at 135°W |
| - GMS (Japan) | at 140°E |
| - Meteosat (EUMETSAT) | at 0° |

Additional geostationary meteorological satellites in reserved positions:

- | | |
|-----------------------------|-----------|
| - GOMS (Russian Federation) | at 76°E |
| - FY-2 (PRC) | at 105°E |
| - INSAT (India) | at 93.5°E |

All these satellites are designed to perform three primary functions or "missions":

- Image taking of the Earth, generally at regular intervals, in a variety of resolutions and spectral bands (infrared and visible);
- Dissemination of computer processed images and derived products to Users.
- Collection of environmental data from fixed or mobile Data Collection Platforms (DCP) via the satellite.

¹ Current CGMS Membership (2009): CMA, CNES, CNSA, ESA, EUMETSAT, IMD, IOC/UNESCO, JAXA, JMA, KMA, NASA, NOAA, ROSCOSMOS, ROSHYDROMET, WMO.

3 CGMS - A SHORT HISTORY

The Coordination of Geostationary Meteorological Satellites came into being on 19 September 1972, when representatives of the European Space Agency (European Space Research Organisation until 1974), Japan and the United States of America, together with observers of the World Meteorological Organization, met in Washington to discuss questions of compatibility among geostationary meteorological satellites. The meeting identified several areas, particularly for the collection of data from moving platforms, where both technical and operational coordination would be needed.

In January 1973, the Union of Soviet Socialist Republics joined CGMS, and WMO changed from Observer status to full Member of CGMS.

India became a member of CGMS in March 1978.

The People's Republic of China became Observer of CGMS in November 1986 and a full Member in 1990.

Also in 1987, EUMETSAT, the European Organisation for the Exploitation of Meteorological Satellites, joined CGMS as the official representative of Europe, and took over the role of CGMS Secretariat.

CGMS formally adopted its Charter in January 1991 and changed its name to the Coordination Group for Meteorological Satellites, which more appropriately reflected the wider interest of CGMS in the coordination of missions and services provided by both geostationary and polar orbiting meteorological satellites and the Group's increasing awareness of the need to provide mutual system back-up in the event of a failure of one satellite in the overall system.

The primary achievements of CGMS have been the standardisation of image dissemination formats, agreement on the use of frequencies allocated to meteorological satellites, the coordination of international data collection and the active consideration of contingency planning. The reader should note that a full history of CGMS activities can be found in the CGMS Consolidated Report and the Reports of Specific Meetings. Copies of these publications can be obtained from the CGMS Secretariat.

For further information on CGMS, please visit www.eumetsat.int

<<http://www.eumetsat.int/Home/Main/AboutEUMETSAT/InternationalRelations/CGMS/index.htm>>

4 THE INTERNATIONAL DATA COLLECTION SYSTEM

The International Data Collection System (IDCS) is designed to support mobile DCPs, i.e. those DCPs on ships, ocean buoys, aircraft or balloons which move from the telecommunications field of view of one geostationary spacecraft to another.

Only self-timed DCPs can use the IDCS channels. Although the normal time slots on IDCS channels are of 1.5 minutes, DCP transmissions must not exceed 60 seconds. The additional time within the slot is used as a 'guard-band' to protect neighbouring time slots in case of drift in the clock controlling transmissions from the DCP.

There are 11 IDCS channels (with centre frequencies spaced 3 kHz apart), from 402.0355 - 402.0655 MHz regardless of the spacecraft. The IDCS operates in the Meteorological Satellite Service in compliance with ITU Radio Regulations.

In special circumstances and on a temporary basis, normally not exceeding one year, fixed DCPs can use the IDCS with the approval of all CGMS members. Such requests should be channelled through the CGMS Secretariat.

5 DATA COLLECTION PLATFORM

A DCP, as defined by CGMS, is an electronic device used to collect observations and measurements of the physical, chemical or biological properties of oceans, rivers, lakes, solid earth and atmosphere. The data are encoded and transmitted by the DCP to a geostationary meteorological satellite within its field of view (see Figure 1). The satellite relays the signal to the central ground station responsible for the control of the satellite itself. There the DCP data are encoded, reformatted, assembled and distributed to users.

The DCPs which are supported by the various satellite systems all around the world are the self-timed type, which transmit their reports automatically within pre-set schedules. The reporting intervals are determined by a pre-set clock inside the platform.

Each DCP is identified by its unique address and the frequency at which it transmits its report. However, DCPs to be used as spares are not normally assigned an address, frequency or time slot since this would waste available resources.

6 DCP REPORT

DCP reports are transmitted at 100 bits per second (bps) and comprise:

- Modulated carrier
 - bit preamble
 - Synchronisation code
 - Address to identify the DCP
 - Environmental data
 - End of transmission sequence to permit the acquisition chain to return to search mode
- } to permit the acquisition chain of the station to acquire, lock and synchronise on the incoming signal

The environmental data should be formatted in a standard WMO code and make use of approved characters of the International Alphabet No. 5, coded over 8 bits. The applicable specifications are provided in Annex 2.

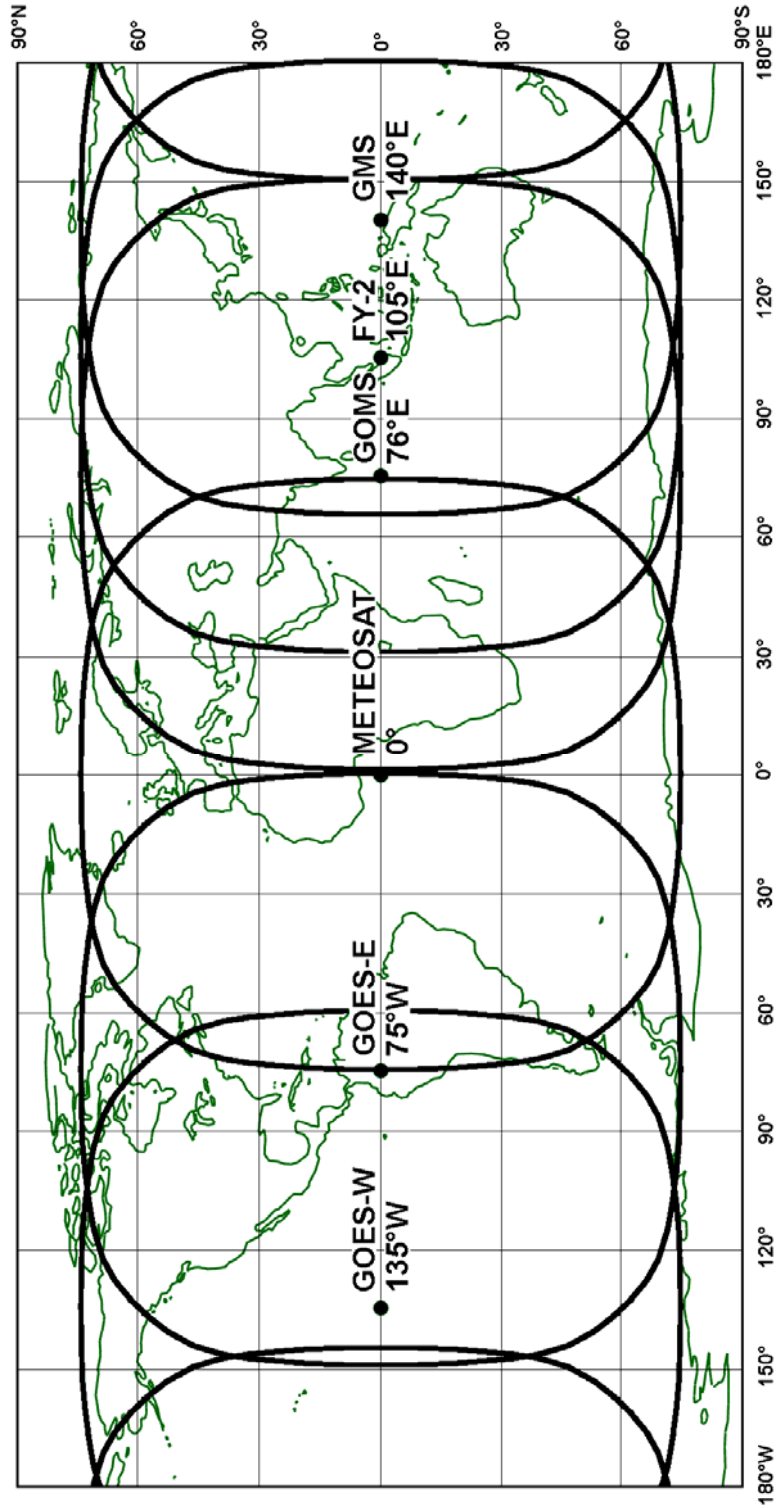

Figure 1 5° Elevation Contours of Satellite Coverage

7 DCP DESIGN

A DCP which is to operate with any of the geostationary meteorological satellites, needs to be carefully designed to provide reliable and stable operations which should never disturb the integrity of the overall Data Collection System. Therefore, the report specifications are completed by design specifications, some recommendations and guidelines, all of which are provided in Annex 3.

8 DCP CERTIFICATION

8.1 General

The DCP certification aims at establishing the compatibility between the new (or modified) DCP Radio Set design and the International Data Collection System. Every time a new or modified DCP design is brought onto the market, it must be "certified", i.e. it must undergo a series of tests to ensure that it is both technically and operationally compatible with the four satellite systems. The tests are in the interests of both the DCP owner, to maximise the return of his investment, and the satellite operator, to avoid the new design interfering with other DCPs.

The DCP is defined in this context as the DCP Radio Set (DCPRS).

Certification of DCPRS may be performed by any of the satellite operators or contractors operating on their behalf.

The manufacturer will receive a certificate once his DCP has successfully passed all certification tests.

Once a DCP has been type-certified, it may be marketed without further certification tests, provided the design is not altered in any way and that the DCP assembly as a whole meets the specified performance standards.

If any modification or design changes are made to the equipment which might affect the performance of the equipment, it will be necessary to re-submit a prototype for testing and re-certification.

8.2 Certification Specifications

The self-timed DCPRS, antenna and interconnecting cable will be tested against the specifications which are provided in Annex 4.

8.3 DCP Radio Set Certificate

For Radio Set certificates please contact the relevant certification and issuing agency which are provided in Annex 5

9 ADMISSION

While the certification aims at establishing the compatibility between the new (or modified) DCP Radio Set design and the International Data Collection System, the admission formally establishes the support provided by all the satellite operators for each DCP being deployed.

Since the objectives of certification and admission are thus different, applications for one will be submitted independently of the other, and by separate organisations (i.e. the DCP manufacturer would normally apply for certification, the DCP user for admission to the system).

Any of the CGMS satellite operators may act as the Admitting Authority for a DCP.

The admission process comprises the allocation of address, frequency and time slots to the DCP and the specification of data handling and distribution, together with any operational procedures which might be necessary to ensure the smooth running of the mission. This procedure is coordinated with WMO and the other satellite operators, since each of them is entitled to admit a DCP on behalf of the others.

The applicant should be the person who is actually going to operate and/or maintain the DCP as opposed to just owning it.

Having reviewed the questionnaire and decided that the DCP is basically admissible; the Admitting Authority will coordinate with the other satellite operators and with WMO the time slot, frequency and address allocations. Once coordination has been achieved, the Admitting Authority will notify the platform operator of the time slot, frequency and address allocations, and may request supplementary information.

The Admitting Authority will keep the other satellite operators and WMO informed on the status of DCP operations. This information may be provided by e-mail or fax.

10 SERVICES PROVIDED BY SATELLITE OPERATORS

10.1 Collection of Data

Each satellite operator will support the collection of data from all international platforms within its area of responsibility. These areas are illustrated in Figure 2. Note that the areas of responsibility, which do not currently include the People's Republic of China, may be redefined by CGMS in the future.

Until such time that a satellite supporting the IDCS is operated at 70°E, the easterly limit of the EUMETSAT area of responsibility will be extended eastward to the Meteosat telecommunication limit. Similarly, the westerly limit of the Japanese area of responsibility will be extended westward to the GMS telecommunication limit (these limits are shown as curved dashed lines in Figure 2).

Furthermore, the restriction related to the processing of messages received from DCPs outside the area of responsibility of the satellite operator is removed until the number of DCPs becomes large enough for duplicated messages to be a problem on the Global Telecommunication System (GTS).

10.2 Eclipse Operation

Around the time of the spring and autumn equinoxes each geostationary satellite moves through the Earth's shadow daily at the time of local midnight ("local" meaning the longitude of the sub-satellite point). While this "eclipse" of the satellite occurs, activities on the satellite are normally curtailed, since the loss of sunlight cuts off the primary energy source for the satellite; however, the Data Collection mission can normally be maintained using the on-board batteries.

10.3 Data Processing

Only reports which are formatted into an appropriate WMO code will be processed by IDCS operators.

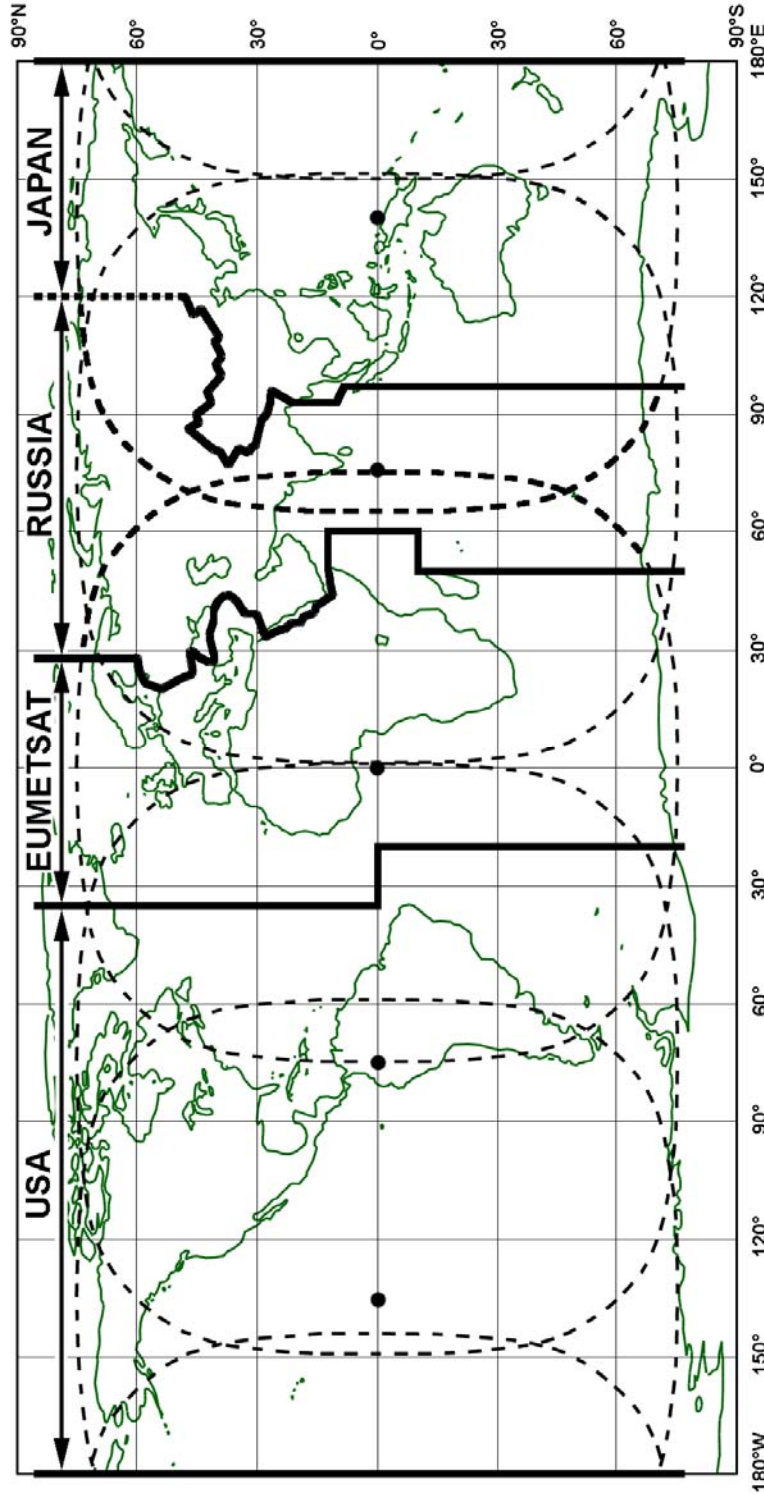

Figure 2 Areas of Responsibility

10.4 Monitoring of DCP Performance

The satellite operators will notify the platform operator of any malfunction of a platform when such information can be determined by the satellite operator. The satellite operators may request the shutting off or repair of a specific platform if it is malfunctioning in such a way that it interferes with other IDCS users.

At the time of admission, the platform operator should discuss with the appropriate satellite operator(s) any diagnostic parameters which have to be relayed.

10.4.1 Monitoring services

Satellite can provide operators with information on the performance of their DCPs to assist operators to resolve any problems with their DCPs.

Information such as:

- number of messages received per day
- carrier level
- modulation index
- frequency offset (from channel centre frequency)

Each DCP report is checked for transmission time. Should this be outside its allocated time-slot, the platform operator and the other satellite operators will be informed by e-mail, fax or letter. Non-reception of reports should be reported by platform operators to EUMETSAT, who will then investigate the problem. Frequency and received signal strength are not monitored continuously; however, spot checks are carried out from time to time. Deviations from normal which have the potential to interfere with other DCS users will be reported to the platform operator and other satellite operators.

10.5 Data Distribution

Satellite operators normally insert their DCP messages into the GTS via the responsible meteorological centre. Other means of dissemination are offered which may vary from one satellite operator to another.

10.5.1 Distribution of data by EUMETSAT

In addition to the GTS, EUMETSAT disseminates DCP message and bulletins using the following mechanisms:

- EUMETCast.
- LRIT
- Web-based interface.

EUMETCast - EUMETSAT's Broadcast System for Environmental Data, is a multi-service dissemination system based on standard Digital Video Broadcast (DVB) technology. It uses commercial telecommunication geostationary satellites to multicast files (data and products) to a wide user community. EUMETCast transmits received DCP messages and WMO GTS bulletins.

DCP messages are also stored, and transferred to an Internet server for a period of 14 days. These data are then made available for registered users to download their DCP data.

Further details of this service can be obtained from the EUMETSAT User Service.

10.5.2 Distribution of data by USA

NOAA/NESDIS also offers the possibility of the following dissemination mechanisms:

- DOMSAT
- LRIT
- Web-based interface
- As of 22 July 2009, the USA will no longer provide a dial-up service for obtaining data

The recommended means of data dissemination remains the GTS.

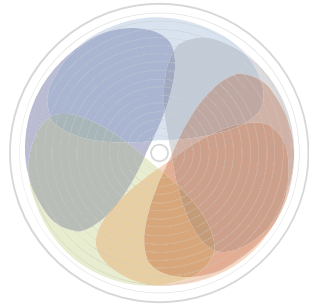

IDCS USERS' GUIDE

ANNEX 1

GLOSSARY OF TERMS AND LIST OF ACRONYMS

GLOSSARY OF TERMS AND LIST OF ACRONYMS

1 GLOSSARY OF TERMS

Admitting Authority

Those entities authorised to admit DCPs into the International Data Collection System.

ASCII

American Standard Code for Information Interchange. A seven-unit code character set designed for automatic data processing systems.

Automated Platform

Data Collection Platforms, where all or part of the message is composed, encoded, and entered into the transmitting equipment automatically.

BCH Code

Bose, Chaudhuri, Hocquenghem Code. A code designed so that a code word of 31 bits can contain two errors and still be recognised.

Certification

Official confirmation by the issuing satellite operator, that an international DCP and its antenna meet a minimum standard of performance.

Data Collection Platform Operators

Members of WMO or other organisations deploying data platforms in accordance with the admission procedures established for the International Data Collection System.

International Alphabet No. 5

This is an abridged version of the International ASCII code.

International Data Collection Platform

Platforms for which responsibility will have to be transferred from one satellite control and data acquisition centre to another.

Manchester Code

Is a method of encoding data, so that a transition occurs at the centre of every bit period.

Manned Platform

A Data Collection Platform, where all or part of the message, is composed, encoded and prepared for transmission by a human operator.

Maximum Linear Sequence

A synchronisation sequence, which has the property when the sequence is shifted, the number of agreements differs from the number of disagreements by exactly one except for perfect synchronisation.

Satellite Operator

Are those entities of the WMO and other international organisations that manage and operate geostationary meteorological satellites which support the IDCS.

Self-timed DCP

Data Collection Platforms which transmit their message following a fixed schedule, and controlled by an internal clock.

Time slot

Period of time allocated for the transmission of a report by a platform.

2 LIST OF ACRONYMS

AC	Alternating Current
AMS	Automated Monitoring System (USA)
ASCII	American Standard Code for Information Interchange
ASDAR	Aircraft to Satellite Data Relay
bps	bits per second
°C	Celsius
CGMS	Coordination Group for Meteorological Satellites
DAMS	Data Acquisition and Monitoring System (USA)
DC	Direct Current
DC	District of Columbia (USA)
DCP	Data Collection Platform
DCPRS	DCP Radio Set
DPU	Data Processing Unit
E	East
EIRP	Effective Isotropic Radiated Power
EOT	End of Transmission
EUMETSAT	European Organisation for the Exploitation of Meteorological Satellites
EUMETCast	EUMETSAT's Broadcast System for Environmental Data
GMS	Geostationary Meteorological Satellite (Japan)
GOES	Geostationary Operational Environmental Satellite (USA)
GOMS	Geostationary Operational Meteorological Satellite (Russia)
GOS	Global Observing System (WMO)
GTS	Global Telecommunication System (WMO)
IA5	International Alphabet No. 5
IDCP	International Data Collection Platform
IDCS	International Data Collection System
IEEE	Institute of Electrical and Electronics Engineers
IF	Intermediate Frequency
ITU-R	International Telecommunication Union - Radio communication Sector
LSB	Least Significant Bit
Meteosat	European (EUMETSAT) geostationary meteorological satellite
MLS	Maximal Linear Sequence
MSB	Most Significant Bit
N	North
NESDIS	National Environmental Satellite, Data and Information Service (USA)
NOAA	National Oceanic and Atmospheric Administration (USA)
NRZ-L	Non-Return to Zero Level
PCM	Pulse Coded Modulation
PLL	Phase Locked Loop
PRC	People's Republic of China
RF	Radio Frequency

rms	root mean square
S	South
UHF	Ultra High Frequency
USA	United States of America
UTC	Universal Time Coordinated
VSWR	Voltage Standing Wave Ratio
W	West
WMO	World Meteorological Organization
WWW	World Weather Watch (WMO)

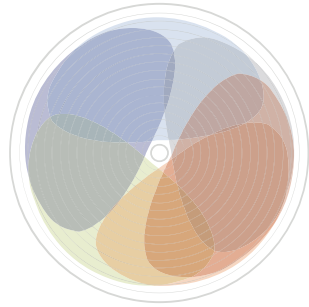

IDCS USERS' GUIDE

ANNEX 2

DCP REPORT CHARACTERISTICS

DCP REPORT CHARACTERISTICS

1 REPORT FORMAT

The DCP report format will comprise the following main elements (see Figure 2.1):

- unmodulated carrier for 5 seconds,
- a 250-bit alternate "0" "1" preamble,
- a 15-bit Maximal Linear Sequence (MLS) code synchronisation word,
- the DCP address which is a 31-bit Bose-Chaudhuri-Hocquenghem (BCH) coded word,
- the environmental data which are a maximum of 649 words, each word being 8 bits long,
- the 31-bit End Of Transmission (EOT) sequence.

The data are Manchester encoded and are transmitted at 100 bps.

1.1 Carrier Preamble

To permit the receiver to lock on to the carrier, the unmodulated carrier is transmitted for five seconds.

1.2 Bit Preamble

To permit the bit conditioner and synchroniser to acquire the bit rate and lock onto it, a preamble of 250 bits, alternate "0" "1", is transmitted prior to the synchronisation word.

1.3 Synchronisation Word

The 15-bit MLS synchronisation word is:

```

1 0 0 0 1 0 0 1 1 0 1 0 1 1 1
↑                               ↑
first transmitted                last transmitted
bit                               bit
    
```

1.4 Address

Each DCP is identified by its address. The address consists of 31 bits where the first 21 constitute the address proper, while the remaining 10 bits are derived from the first 21 bits and serve as an error check.

This computer-oriented allocation of 21-bit addresses is performed in a manner which is also convenient for control purposes, by making them easily recognisable for the operators. For this purpose, the hexadecimal form is used.

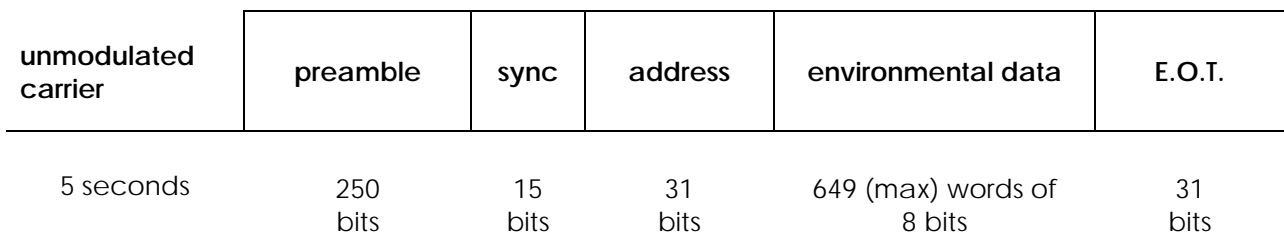

Figure 2.1 Report Format

The allocation of addresses is carried out as follows:

(a) The first set of 4 bits denotes the admitting authority of the platform:

EUMETSAT	0001 (1)
	0010 (2)
	0011 (3)
JAPAN	0100 (4)
	0101 (5)
	0110 (6)
PRC	1101 (E)
RUSSIAN	0000 (0)
FEDERATION	1000 (8)
	1001 (9)
USA	1010 (A)
	1011 (B)
	1100 (C)
	0111 (7)
	1111 (F)
Spare	1110 (D)

(b) The second set denotes the type of platform:

ASDAR	0000 (0)
	0010 (2)
Ships	0001 (1)

The remaining 14 combinations are not yet allocated.

(c) The third, fourth and fifth sets of 4 bits identify the vehicle carrying the platform:

For ASDAR	nnn	the aircraft
For ship	xxx	the ship

(d) The 21st bit = 0.

The 31-bit address word is generated by the matrix multiplication of the 21-bit address defined above by the 21/31 BCH generator matrix:

$$\mathbf{31\text{-bit address}} = \mathbf{21\text{-bit address}} \times \mathbf{21/31\ BCH\ generator\ matrix}$$

The 21/31 bit BCH generator matrix is given in Table 2.1.

1.5 Environment Data

The data pertaining to one report consist of a maximum of 649 words of 8 bits.

1.5.1 General

The only authorised forms of data are the approved characters from the International Alphabet No. 5 coded over 8 bits. The approved characters are shown in Figure 2.2.

b1 is transmitted first

b8 is transmitted last

b8 is the parity bit odd

b8 = 0 if b1 through b7 contain an odd number of "ones".

The following control characters must not appear in the data message:

ACK, CAN, DLE, ENQ, EOT, ETB, ETX, GS, NAK, RS, SOH, STX and SYN.

The data should be formatted in one of the following standard WMO codes:

FM 13 VII SHIP report of surface observation from a sea station

FM 33 V PILOT SHIP upper wind report from a sea station

FM 36 V TEMP SHIP upper level pressure, temperature, humidity and wind report from a sea station

FM 41 IV CODAR upper air report from an aircraft (other than weather reconnaissance aircraft)

FM 42 IX AMDAR aircraft report

FM 63 V BATHY report of Bathythermal observation

FM 64 V TESAC Temperature, Salinity and Current report from a sea station.

All these codes are described in the WMO document No. 306 - "Manual on Codes".

The WMO bulletin abbreviated heading should not be included in the DCP report. Although observation time may be included in the DCP report, it is not recommended.

In order not to confuse the meteorological community, it is requested that national practices regarding the coding of certain elements in reports, analyses or forecasts for international exchange be abandoned and that:

- the reporting of horizontal visibility at surface conforms to Regulation 11.4.1 of WMO;
- the reporting of wind speed should be in metres per second.

				b_7	0	0	0	0	1	1	1	1
				b_6	0	0	1	1	0	0	1	1
				b_5	0	1	0	1	0	1	0	1
b_4	b_3	b_2	b_1		0	1	2	3	4	5	6	7
0	0	0	0	0			SP	0		P		
0	0	0	1	1				1	A	Q		
0	0	1	0	2				2	B	R		
0	0	1	1	3				3	C	S		
0	1	0	0	4				4	D	T		
0	1	0	1	5				5	E	U		
0	1	1	0	6				6	F	V		
0	1	1	1	7			'	7	G	W		
1	0	0	0	8			(8	H	X		
1	0	0	1	9)	9	I	Y		
1	0	1	0	A	LF			:	J	Z		
1	0	1	1	B			+		K			
1	1	0	0	C			,		L			
1	1	0	1	D	CR		-	=	M			
1	1	1	0	E			.		N			
1	1	1	1	F			/	?	O			

Figure 2.2 Approved Characters of the International Alphabet No. 5

1.6 End of Transmission

The end of transmission code is 31 bits long. The first 8 bits correspond to the EOT character of the International Alphabet No. 5.

```

00100000101110110101001111100011
| b1      b8 |
  EOT
↑
first transmitted bit                ↑
                                      last transmitted bit
    
```

2 RADIO FREQUENCY UP-LINK

2.1 Modulation Technique

The carrier is phase modulated by the serial bit stream, the modulation index being 60°. The phase of the unmodulated carrier should correspond to 0°.

Since the data is Manchester coded, the "0" consists of +60° carrier phase shift for 5 milliseconds followed by -60° carrier phase shift for 5 milliseconds, while the "1" consists of -60° carrier shift for 5 milliseconds followed by +60° carrier phase shift for 5 milliseconds (see Figure 2.3).

The data asymmetry shall not exceed ±1% of the bit period.

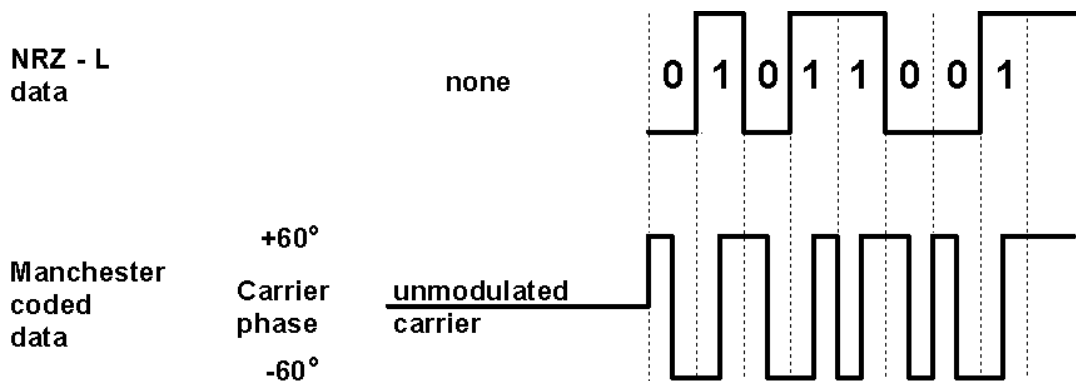

Figure 2.3 Definition of the Modulation

2.2 Radiated Power

The radiated power shall be such the power flux at the spacecraft is -145 dBW/m² ±5 dB.

Provision should be made to ensure that the maximum allowed power flux is not exceeded under any combination of operating conditions. The effective Isotropic radiated Power shall not exceed 52 dBm.

2.3 Antenna Polarisation

Polarisation shall be right-hand circular, according to IEEE Standard 65.34.159, and have an axial ratio of equal to or less than 6 dB on axis.

2.4 Transmission Frequency

The transmitted radio frequency shall use the 11 IDCS channels (with centre frequencies spaced 3 kHz apart), from 402.0355 - 402.0655 MHz regardless of the spacecraft.

Table 2.2 provides the frequency of the unmodulated carrier for the 11 channels.

Channel number	Frequency MHz
1	402.0355
2	402.0385
3	402.0415
4	402.0445
5	402.0475
6	402.0505
7	402.0535
8	402.0565
9	402.0595
10	402.0625
11	402.0655

Table 2.2 IDCS Channel Frequencies

Nominal start time	Earliest start of transmission	Latest end of transmission
HH.00.00	(HH-01).59.45	HH.01.15
HH.01.30	HH.01.15	HH.02.45
HH.03.00	HH.02.45	HH.04.15
HH.04.30	HH.04.15	HH.05.45
HH.06.00	HH.05.45	HH.07.15
HH.07.30	HH.07.15	HH.08.45
HH.09.00	HH.08.45	HH.10.15
HH.10.30	HH.10.15	HH.11.45
HH.12.00	HH.11.45	HH.13.15
HH.13.30	HH.13.15	HH.14.45
HH.15.00	HH.14.45	HH.16.15
HH.16.30	HH.16.15	HH.17.45
HH.18.00	HH.17.45	HH.19.15
HH.19.30	HH.19.15	HH.20.45
HH.21.00	HH.20.45	HH.22.15
HH.22.30	HH.22.15	HH.23.45
HH.24.00	HH.23.45	HH.25.15
HH.25.30	HH.25.15	HH.26.45
HH.27.00	HH.26.45	HH.28.15
HH.28.30	HH.28.15	HH.29.45
HH.30.00	HH.29.45	HH.31.15
HH.31.30	HH.31.15	HH.32.45
HH.33.00	HH.32.45	HH.34.15
HH.34.30	HH.34.15	HH.35.45
HH.36.00	HH.35.45	HH.37.15
HH.37.30	HH.37.15	HH.38.45
HH.39.00	HH.38.45	HH.40.15
HH.40.30	HH.40.15	HH.41.45
HH.42.00	HH.41.45	HH.43.15
HH.43.30	HH.43.15	HH.44.45
HH.45.00	HH.44.45	HH.46.15
HH.46.30	HH.46.15	HH.47.45
HH.48.00	HH.47.45	HH.49.15
HH.49.30	HH.49.15	HH.50.45
HH.51.00	HH.50.45	HH.52.15
HH.52.30	HH.52.15	HH.53.45
HH.54.00	HH.53.45	HH.55.15
HH.55.30	HH.55.15	HH.56.45
HH.57.00	HH.56.45	HH.58.15
HH.58.30	HH.58.15	HH.59.45

Table 2.3 One minute 30 Seconds Time Slot Schedule

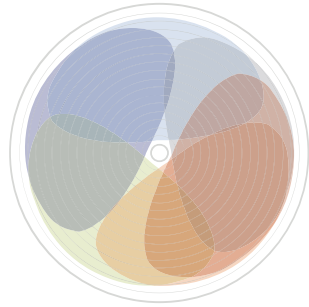

IDCS USERS' GUIDE

ANNEX 3

DCP DESIGN

DCP DESIGN

1 DESIGN SPECIFICATIONS

Every DCP must generate reports with characteristics as described in Annex 2 and should also conform to the following technical specifications.

1.1 Start Signal

The DCPRS shall provide a start signal generated by the internal timer at the required time of transmission. This start signal will initiate the read-out of data from the interface unit.

1.2 Timing Accuracy

The timer which determines the DCPRS reporting time shall be of sufficient accuracy to ensure that the DCPRS reporting time is always within 15 seconds of its assigned reporting time. The timer shall provide a reporting interval of 1 to 12 hours in one hour steps. Furthermore, the timer shall be capable of being set in steps of 30 seconds.

1.3 Clock Output

The DCPRS shall provide a 100 Hz clock frequency which shall be used to clock in the reply data. The 100 Hz clock frequency shall have a long-term and temperature stability better than 50 parts per million.

1.4 Data Input

The DCPRS shall accept, from an interface unit with environmental sensors or manual data input device, a serial bit flow NRZ-L, 100 bps coded in International Alphabet No. 5.

1.5 Fail-Safe Design

The DCPRS shall incorporate a "fail-safe" design feature such that a malfunction of the equipment will in no way cause continuous transmission. Furthermore, provision shall be made to automatically terminate the transmission at a time not exceeding the platform's allocated transmission slot plus 30 seconds.

1.6 Transmit Frequency Stability

1.6.1 Temperature and Long-Term stability

The transmitting carrier frequency stability shall be better than 1.5 (EUMETSAT requires 0.75) parts per million for temperature variations and aging combined. This specification applies typically over the temperature range of -20°C to +50°C and over one year, unless specified differently by the DCP Operator, and agreed by the admitting satellite operators.

1.6.2 Short-Term stability

The phase jitter on the transmit carrier shall be less than 3 degrees rms when measured through a phase lock loop two-sided noise bandwidth (2BL) of 20 Hz and within 2 kHz (see Figure 3.1).

2 RECOMMENDATIONS AND GUIDELINES

2.1 Radio Set/Sensors Interface

There are two ways for data to be entered into the DCPRS:

- (a) automatically, directly from sensors (see Figure 3.2);
- (b) manually, by using a manual input device (see Figure 3.3).

In both cases an interface unit is required with the following capabilities:

- 1) output of data when requested by the DCPRS in International Alphabet No. 5;
- 2) receiving the 100 Hz clock signal provided by the DCPRS and using this signal to clock the data into the DCPRS in a NRZ-L serial bit stream at a rate of 100 bps;
- 3) starting the output of data by the start signal provided by the DCPRS.

Amongst other items, the interface unit will include a suitable storage device which shall be loaded with the data by the operator, or automatically loaded directly from sensors before the expected transmission time, and which shall be read out at 100 bps by the radio set at the transmission time. The read-out is initiated by the "start pulse" provided by the DCPRS.

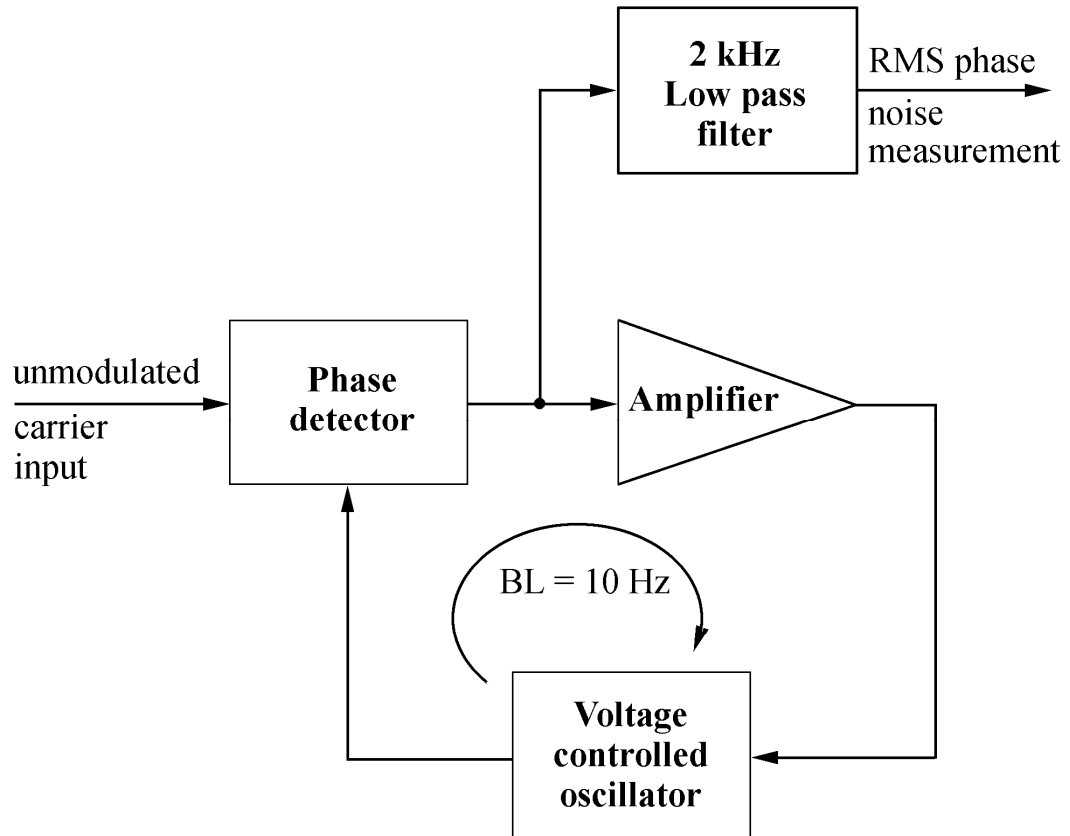
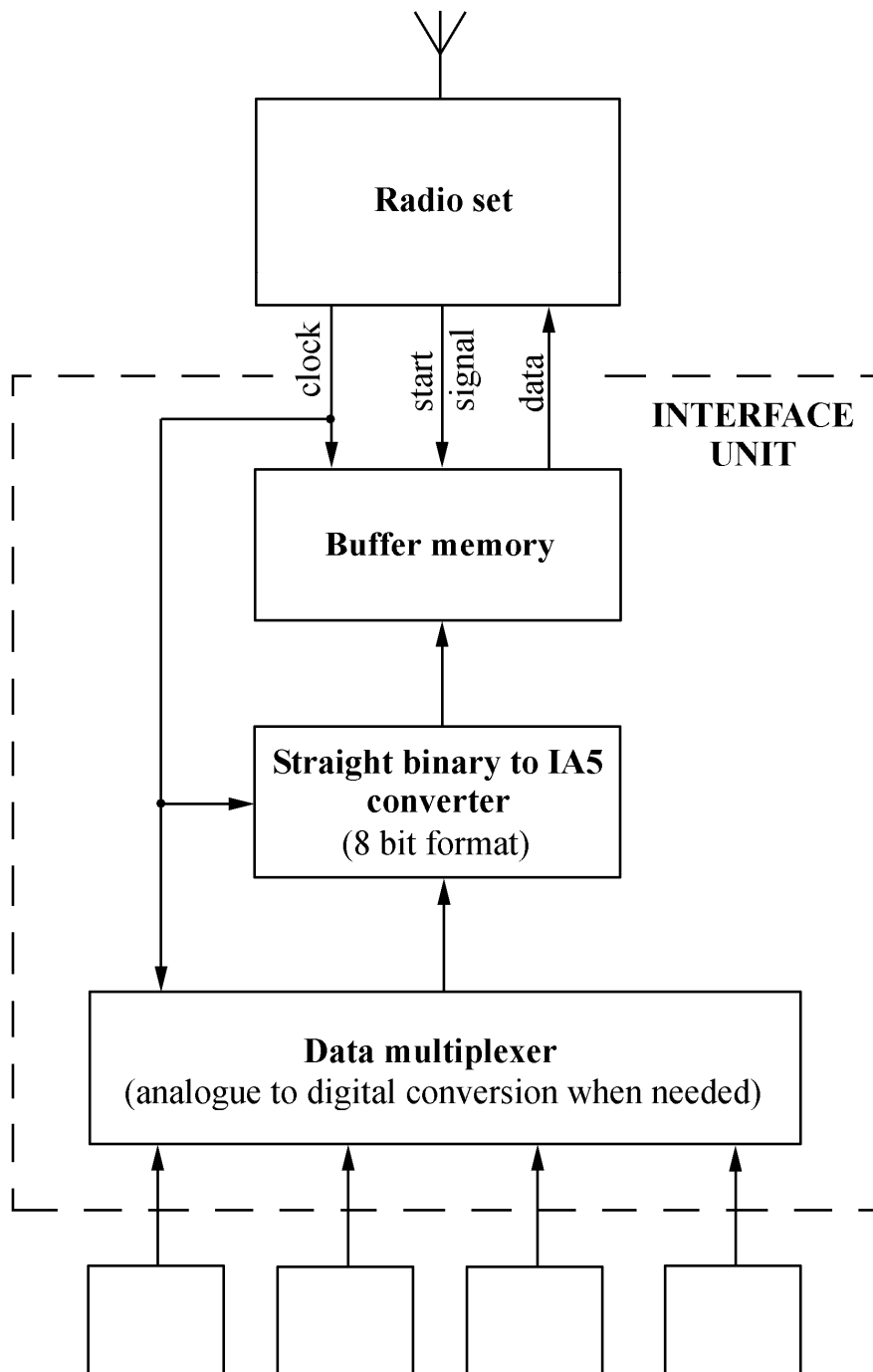

Figure 3.1 Phase Jitter Measurement Principle



Meteorological (or environmental) sensors (analogue or digital):

- Buffer memory could be permanently loaded and updated at a rate higher than 100 bps.
- Start signal initiates the read-out of data from the buffer memory in its present status and in a given order.

Figure 3.2 Interfaces to Automatic Input from Sensors

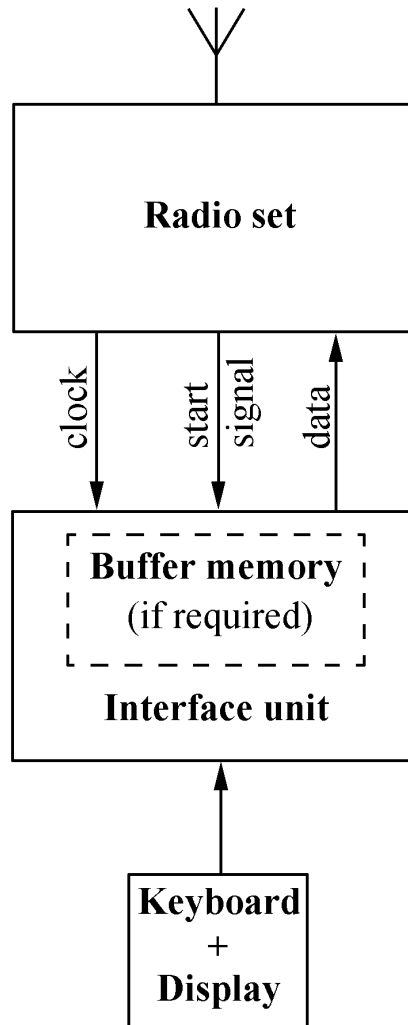

- Clock 100 Hz
- Start Signal delivered by the radio set control module, either upon interrogation or from the internal timer, initiates the read-out of the data at the right transmission time.
- Data serial 100 bps bit stream NRZ-L coded in International Alphabet No. 5, 8-bit word.

Figure 3.3 Interfaces to Manual Input

Examples of manual input devices are the following:

- 1) keyboard with display unit for message verification;
- 2) thumb wheel character switches;
- 3) teletypewriter with paper tape punch.

The first two devices will normally include storage of information in which case storage in the interface unit will not be required. In the case of the teletypewriter, the data will automatically be entered in International Alphabet No. 5 (IA5). However, some other input devices may not automatically give the data in IA5. In that case, the interface unit should also include a converter, to be inserted between the manual input device and the buffer memory.

2.2 Pre-modulation Filter

It is recommended that a 300 Hz, 2-pole Bessel pre-modulation filter be included. In the absence of such a filter, the modulation index shall be 60° with a tolerance of +0% -10%. When the filter is included, the modulation index shall be such that a carrier reduction of between 6 dB and 4.6 dB is achieved.

In both cases, those tolerances shall be observed over the temperature range of -20°C to +50°C and for all "0" or all "1" data as well as for alternate "0" "1" data.

2.3 Protection of RF Output Circuit

It is recommended that a circulator between the RF power output amplifier and the antenna be included in order to ensure proper operation even under conditions where the standing wave ratio is abnormal (for example, when ice covers the antenna).

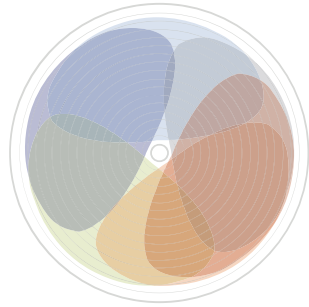

IDCS USERS' GUIDE

ANNEX 4

CERTIFICATION SPECIFICATIONS

CERTIFICATION SPECIFICATIONS

1 RADIO FREQUENCY OUTPUT POWER

The Effective Isotropic Radiated Power (EIRP) of the DCPRS and antenna including the interconnecting cable shall not exceed 52 dBm under any combination of operational conditions.

2 TRANSMIT FREQUENCY

The transmitted radio frequency shall use the 11 IDCS channels (with centre frequencies spaced 3 kHz apart), from 402.0355 - 402.0655 MHz regardless of the spacecraft.

Table 4.1 provides the frequency of the unmodulated carrier for the 11 IDCS channels.

Channel number	Frequency MHz
1	402.0355
2	402.0385
3	402.0415
4	402.0445
5	402.0475
6	402.0505
7	402.0535
8	402.0565
9	402.0595
10	402.0625
11	402.0655

Table 4.1 IDCS Channel Frequencies

3 FREQUENCY MANAGEMENT

3.1 Temperature and Long-Term Frequency Stability

The transmitting carrier frequency stability shall be better than 1.5 (EUMETSAT requires 0.75) parts per million against temperature variations and aging together. This specification applies typically over the temperature range of -20°C to +50°C and over one year, unless specified differently by the DCP Operator, and agreed by the admitting satellite operator.

3.2 Short-Term

The phase jitter on the transmit carrier shall be less than 3 degrees rms when measured through a phase lock loop two-sided noise bandwidth (2 BL) of 20 Hz and within 2 kHz (see Figure 4.1).

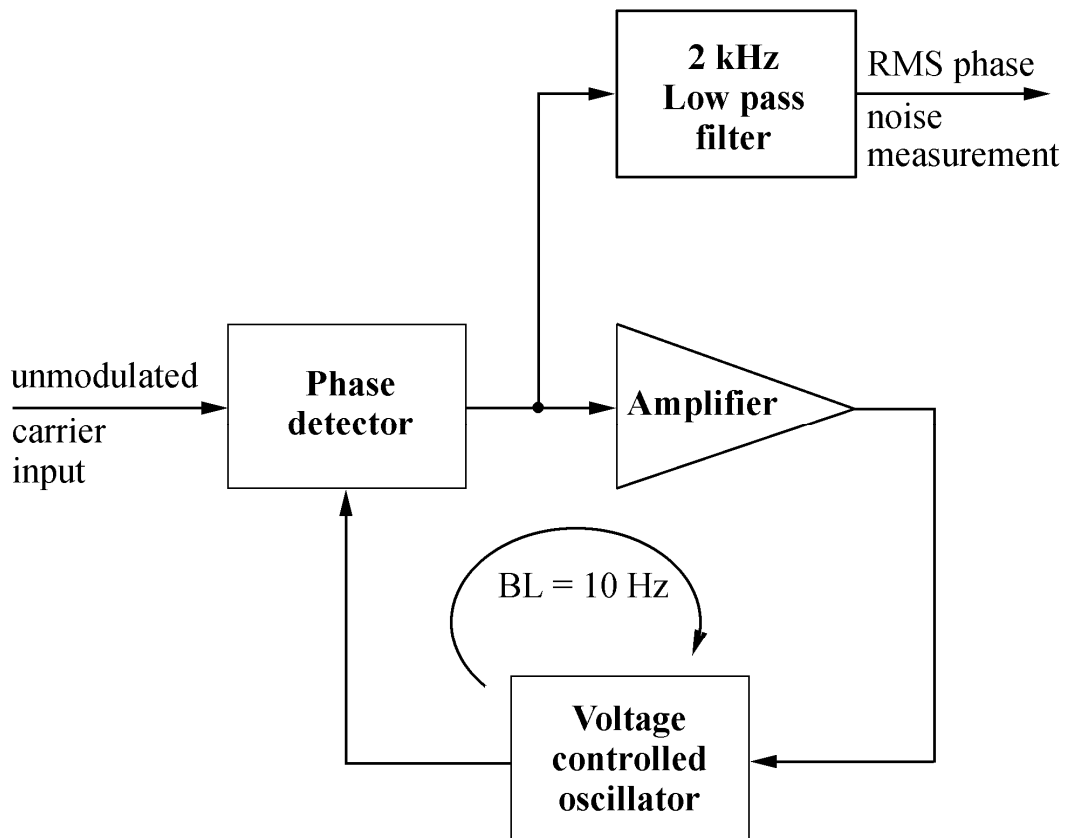

Figure 4.1 Phase Jitter Measurement Principle

4 ELECTROMAGNETIC INTERFERENCE

Any spurious transmitter emissions, when measured with modulation and with antenna and duplexer connected, shall be down from the unmodulated carrier level by 60 dB (referred to a measurement bandwidth of 500 Hz, corresponding to -62 dB at 300 Hz).

5 TRANSMISSION FORMAT

5.1 Preamble

All data transmission shall be preceded by the following sequence:

- a minimum of 4.9 seconds of unmodulated carrier;
- a minimum of 2.4 seconds of alternative "1" and "0" bits;
- the 15-bit (0.15 seconds) Maximal Length Sequence (MLS) synchronisation word:

```

1 0 0 0 1 0 0 1 1 0 1 0 1 1 1
↑                               ↑
first                           last
transmitted bit                 transmitted bit
    
```

- the 31-bit (0.31 seconds) Bose-Chaudhuri-Hocquenghem (BCH) coded address word:

```

0 0 1 1 0 1 0 0 1 0 0 0 0 1 0 1 0 1 1 1 0 1 1 0 0 0 1 1 1 1 1
↑                               ↑
first transmitted bit           last transmitted bit
    
```

The maximum duration of the preamble shall be 8.0 seconds.

5.2 Data

All data must use approved characters from the International Alphabet No. 5 coded over 8 bits. The approved characters are shown in Figure 4.2.

- b1 is transmitted first
- b8 is transmitted last
- b8 is the parity bit odd
- b8 = 0 if b1 through b7 contain an odd number of "ones".

The following control characters should not appear in the data message:

ACK, CAN, DLE, ENQ, EOT, ETB, ETX, GS, NAK, RS, SOH, STX and SYN.

All transmissions will have a data rate of 100 ±0.005 bps and will be Manchester encoded.

The carrier shall be modulated in the following manner (see Figure 4.3):

- (a) a data "0" shall consist of +60° carrier phase shift for 5 milliseconds followed by -60° carrier phase shift for 5 milliseconds;

- (b) a data "1" shall consist of -60° carrier phase shift for 5 milliseconds followed by +60° carrier phase shift for 5 milliseconds;
- (c) the phase of the 5 second unmodulated carrier shall correspond to the phase 0° of the modulated carrier.

The data asymmetry shall not exceed ±1% of the bit period.

				b_7	0	0	0	0	1	1	1	1
				b_6	0	0	1	1	0	0	1	1
				b_5	0	1	0	1	0	1	0	1
b_4	b_3	b_2	b_1		0	1	2	3	4	5	6	7
0	0	0	0	0			SP	0		P		
0	0	0	1	1				1	A	Q		
0	0	1	0	2				2	B	R		
0	0	1	1	3				3	C	S		
0	1	0	0	4				4	D	T		
0	1	0	1	5				5	E	U		
0	1	1	0	6				6	F	V		
0	1	1	1	7			'	7	G	W		
1	0	0	0	8			(8	H	X		
1	0	0	1	9)	9	I	Y		
1	0	1	0	A	LF			:	J	Z		
1	0	1	1	B			+		K			
1	1	0	0	C			,		L			
1	1	0	1	D	CR		-	=	M			
1	1	1	0	E			.		N			
1	1	1	1	F			/	?	O			

Figure 4.2 Approved Characters of the International Alphabet No. 5

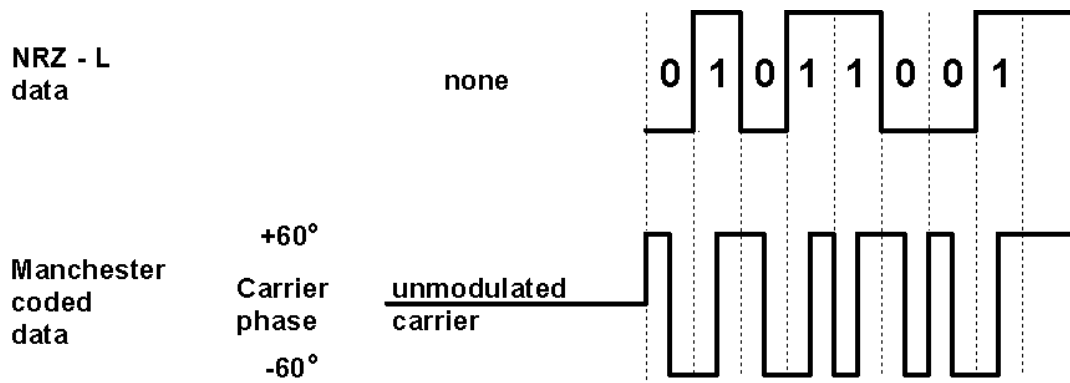

Figure 4.3 Definition of the Modulation

5.3 End of Transmission

Immediately after sending the sensor data, the 31-bit End of Transmission (EOT) code will be transmitted:

```
0 0 1 0 0 0 0 0 1 0 1 1 1 0 1 1 0 1 0 1 0 0 1 1 1 1 0 0 0 1 1
  ↑                                     ↑
  first transmitted bit                 last transmitted bit
```

This code shall be sent continuously at the end of the sensor data (no break) and the radio set will then return to the stand-by condition.

6 FAIL-SAFE DESIGN

The DCPRS shall incorporate a "fail-safe" design feature in order that a malfunction of the equipment shall in no way cause continuous transmission. Furthermore, provision shall be made to automatically terminate the transmission at a time not exceeding the platform's allocated message transmission slot plus 30 seconds.

7 ANTENNA POLARISATION

Polarisation shall be right-hand circular, according to IEEE Standard 65.34.159, and have an axial ratio of equal to or less than 6 dB on axis.

8 START SIGNAL

The DCPRS shall provide a start signal at the required time of transmission. This start will initiate the read-out of data from the interface unit.

9 TIMING ACCURACY

The timer which determines the DCPRS reporting time shall be of sufficient accuracy to ensure that the DCPRS reporting time is maintained to within 15 seconds of its assigned reporting time. The timer shall provide a reporting interval of between 1 and 12 hours in one hour steps. Furthermore, the timer shall be capable of being set in steps of 30 seconds.

10 CLOCK OUTPUT

The DCPRS shall provide a 100 Hz clock frequency which shall be used to clock in the reply data. The 100 Hz clock frequency shall have a long-term and temperature stability better than 50 parts per million.

11 DATA INPUT

The DCPRS shall accept, from an interface unit with environmental sensors or manual data input device, a serial bit flow NRZ-L, 100 bps coded in International Alphabet No. 5.

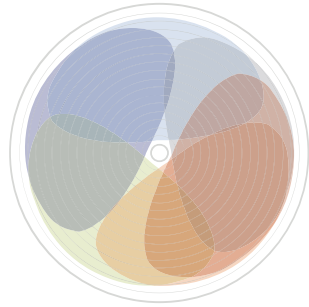

IDCS USERS' GUIDE

ANNEX 5

ADDRESS LIST FOR OPERATIONAL ENGINEERING MATTERS

CMA

China Meteorological Administration
46 Zhong Guan Cun South Ave.,
Beijing, 100081, People's Republic of China

<http://www.cma.gov.cn>

Mr Xu Jianmin
Member of Chinese Academy of Engineering
Satellite Meteorological Center
Tel: +86 10 6840 6367
Fax: +86 10 6217 2724
E-mail: xujm (at) cma.gov.cn

Dr Yang Jun
Director-General
National Satellite Meteorological Center
Tel.: +86 10 6840 7108
Fax: +86 10 6217 2724
E-mail: junyang (at) nsmc.cma.gov.cn

EUMETSAT

EUMETSAT
Eumetsat-Allee 1
D-64295 Darmstadt, Germany

<http://www.eumetsat.int>

Mr Mikael Rattenborg
Director of Operations
EUMETSAT
Telex: 4197335 emet d
Tel.: +49 6151 807-368
Fax: +49 6151 807 304
E-mail: mikael.rattenborg (at) eumetsat.int

IMD

India Meteorological Department
Lodi Road
110003 New Delhi, India

<http://www.imd.gov.in>

Director, Satellite Meteorology
Tx: 3166 494

JAXA

Japan Aerospace Exploration Agency (JAXA)
2-1-1 Sengen, Tsukuba, Ibaraki, 305-8505,
Japan

<http://www.jaxa.jp>

Mr Kazuo Umezawa
Engineer,
Earth Observation Research Center (EORC),
Space Applications Mission Directorate
Tel.: +8129 868 2486
Fax: +8129 868 2961
E-mail: umezawa.kazuo (at) jaxa.jp

JMA/MSC

Japan Meteorological Agency (JMA)
3-235 Nakakiyoto, Kiyose-shi
Tokyo 204-0012, Japan

<http://mscweb.kishou.go.jp/index.htm>

Mr Tomoo Ohno
Head of System Engineering Division
Meteorological Satellite Center (MSC)
Tel.: +81 42 493 4970
Fax: +81 42 492 2433
E-mail: cgmsplen (at) dpc.kishou.go.jp

NOAA/NESDIS

NOAA/NESDIS
4231 Suitland Road
NSOF, Rm. 1605, E/OSO
Suitland, Maryland, 20746, USA

<http://www.noaa.com>

Mrs Kathleen A. Kelly
Director, Office of Satellite Operations
Tel: +1 301 817 4000
Fax: +1 301 817 7901
E-mail: kathy.kelly (at) noaa.gov

ROSHYDROMET/SRC PLANETA

SRC Planeta
7, Bolshoy Predtechensky Per.
Moscow, 123242, Russia

Mrs Tatjana Bourtseva
Tel: +7 499 795 2421
Fax: +7 499 252 6210

E-mail: burc (at) planet.iitp.ru